

Motor-Flansch-Senkbremsventile für Danfoss Motoren OMS

Typ VBCDF DE OMS – Typ VBCDF SE OMS

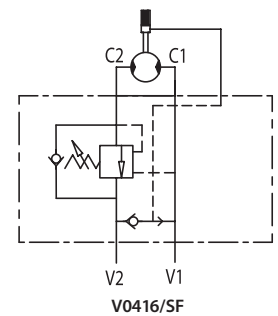

Druckabfall (Öltemperatur: 50 °C/Ölviskosität: 30 cSt)

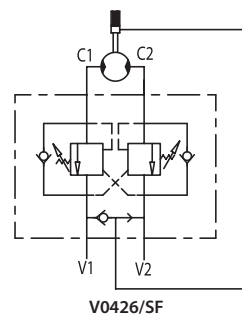
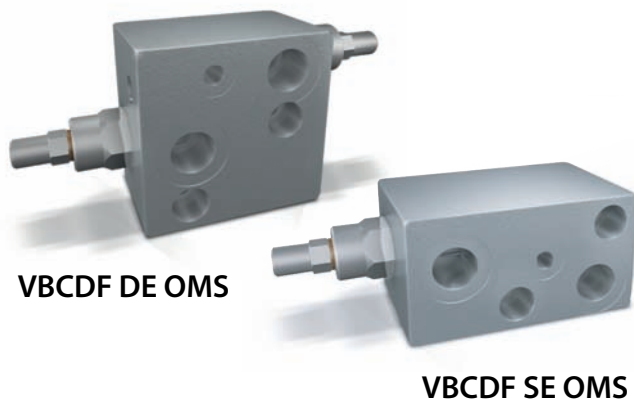
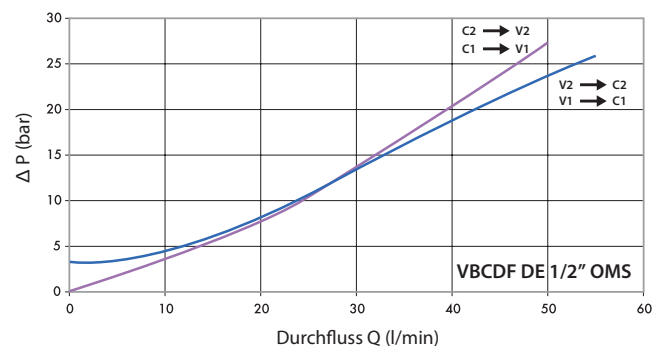
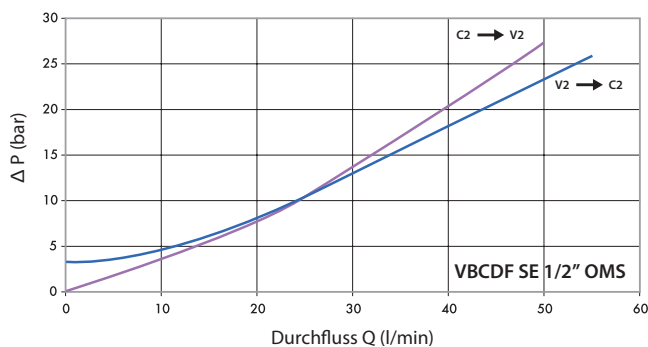

Code	Typ	Pilot Ratio	max. Durchfluss (l/min)	max. Arbeitsdruck (bar)
V0416	VBCDF 1/2" SE OMS	1:4.5	50	350
V0416/SF	VBCDF 1/2" SE OMS SF	1:4.5	50	350
V0426	VBCDF 1/2" DE OMS	1:4.5	50	350
V0426/SF	VBCDF 1/2" DE OMS SF	1:4.5	50	350

VBCDF SE OMS

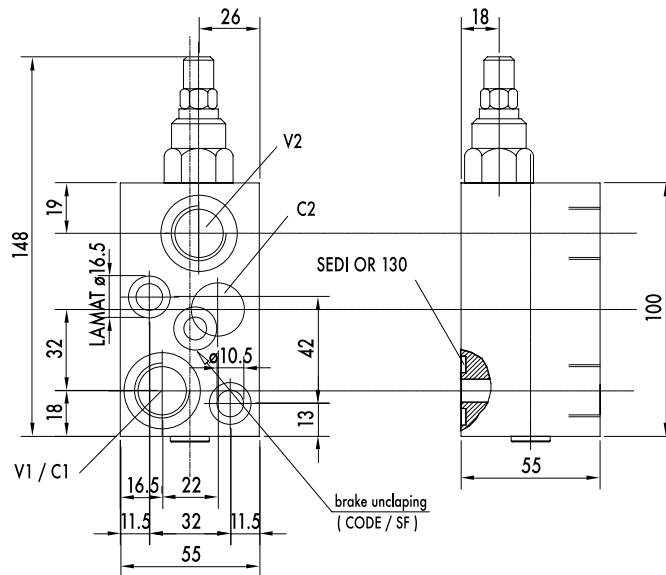

VBCDF DE OMS

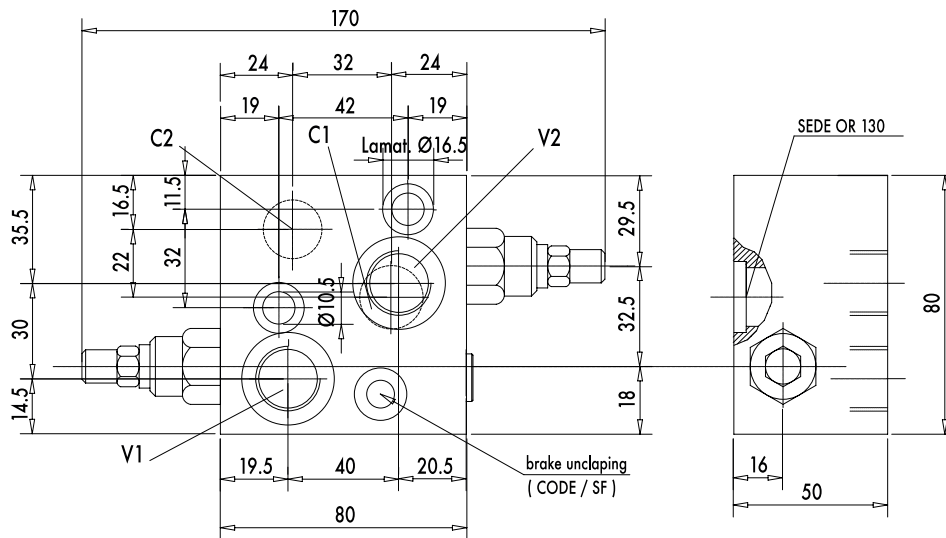

Code	Typ	V1 – V2	C1 – C2 (mm)	Gewicht (kg)
V0416	VBCDF 1/2" SE OMS	G 1/2"	ø9	1.700
V0416/SF	VBCDF 1/2" SE OMS SF	G 1/2"	ø9	1.700
V0426	VBCDF 1/2" DE OMS	G 1/2"	ø9	2.150
V0426/SF	VBCDF 1/2" DE OMS SF	G 1/2"	ø9	2.150